

Series PVX6012

Microelectronic Power IC Relay
IGBT Photovoltaic Relay
Single Pole, Normally Open,
0-280VAC (RMS) or 0-400VDC, 1.0A AC/DC

General Description

The PVX6012 Photovoltaic Relay is a single-pole, normally open solid-state relay that can replace electromechanical relays in many applications. It utilizes an IGBT output switch, driven by an integrated circuit photovoltaic generator of novel construction. The output switch is controlled by radiation from a GaAIAs light emitting diode (LED) which is optically isolated from the photovoltaic generator.

The PVX6012 is ideally suited for switching medium power loads. It offers high operating speed, low and stable on-state voltage drop as well as low off-state leakage current.

PVX6012 relays are packaged in a 14-pin, molded DIP package in thru-hole. It is available in standard plastic shipping tubes.

Applications

- Test Equipment
- Industrial Controls and Automation
- Electromechanical Relay Replacement
- Mercury-wetted Relay Replacement

Features

- IGBT and HEXFRED™ output ■
- Bounce-free operation ■
- High load current capacity ■
- Low off-state leakage current ■
- 3,750 V_{RMS} I/O isolation ■
- Solid-State reliability ■
- UL recognized and CSA certified ■

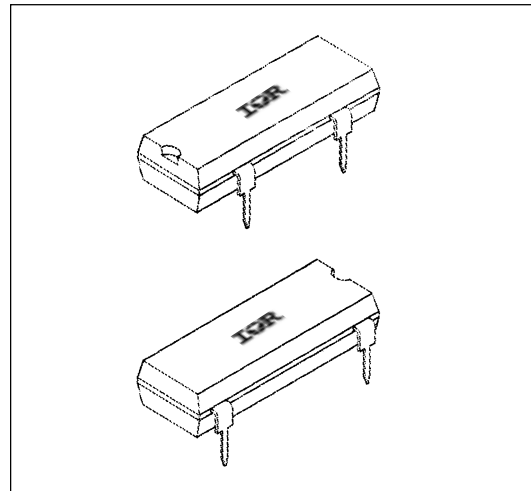

Part Identification

PVX6012 through-hole

Electrical Specifications ($-40^{\circ}\text{C} \leq T_A \leq +85^{\circ}\text{C}$ unless otherwise specified)

INPUT CHARACTERISTICS	Limits	Units
Minimum Control Current (see figure 1)	5.0	mA
Maximum Control Current for Off-State Leakage @ $T_A = +25^{\circ}\text{C}$	0.4	mA
Control Current Range (Caution: current limit input LED, see figure 6)	5.0 to 25	mA
Maximum Reverse Voltage	7.0	V

OUTPUT CHARACTERISTICS	Limits	Units
Transient Overvoltage Protection	600	V(DC or AC peak)
Operating Voltage	0-280 0-400	V(AC) RMS V(DC)
Maximum Load Current @ $T_A = +40^{\circ}\text{C}$	1.0	A(DC)
5mA Control (see figure 1 and Note 1)	1.0	A (AC) RMS
Maximum Surge Current		
non-repetitive, 1 sec.	5	A(DC)
non-repetitive 20 msec. (see figure 2)	20	A(DC)
Maximum On-State Voltage Drop @ $T_A = +25^{\circ}\text{C}$ For 1A pulsed load, 5mA Control (see figures 3 and 4)	2.5	V
Maximum Off-State Leakage @ $T_A = +25^{\circ}\text{C}$, $\pm 400\text{V}$ (see figure 5)	10	μA
Maximum Turn-On Time @ $T_A = +25^{\circ}\text{C}$ (see figure 8) For 1A, 400 V _{DC} load, 5mA Control	7	ms
Maximum Turn-Off Time @ $T_A = +25^{\circ}\text{C}$ (see figure 8) For 1A, 400 V _{DC} load, 5mA Control	1	ms
Maximum Output Capacitance @ 100V _{DC} (see figure 7)	50	pF

GENERAL CHARACTERISTICS	Limits	Units
Minimum Dielectric Strength, Input-Output	3750	V _{RMS}
Minimum Insulation Resistance, Input-Output @ $T_A = +25^{\circ}\text{C}$, 50%RH, 100V _{DC}	10^{12}	Ω
Maximum Capacitance, Input-Output	1.0	pF
Maximum Pin Soldering Temperature (10 seconds maximum)	+260	
Ambient Temperature Range:		$^{\circ}\text{C}$
Operating	-40 to +85	
Storage	-40 to +100	

Connection Diagram

Notes:

- ① Load handling capability to 0.2 power factor requires overvoltage protection.

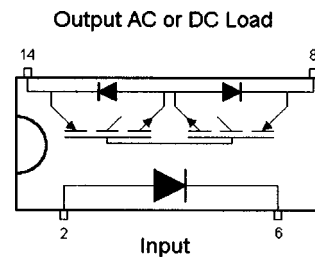

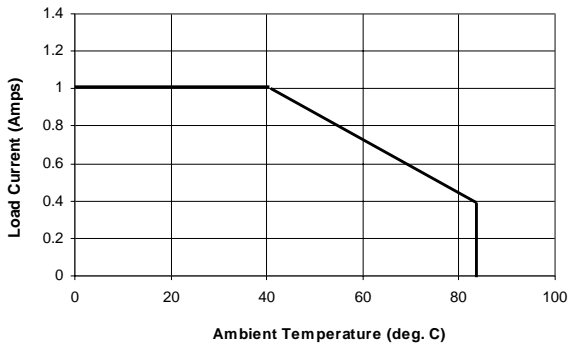

Figure 1. Current Derating Curve

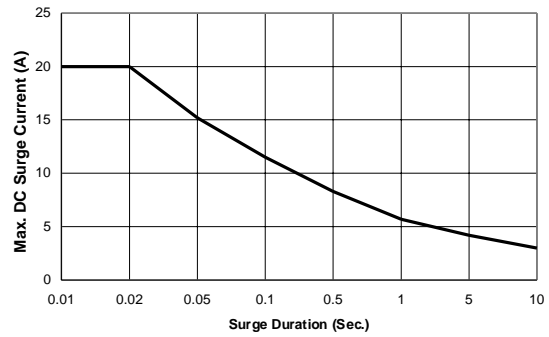

Figure 2. Surge Current Capability

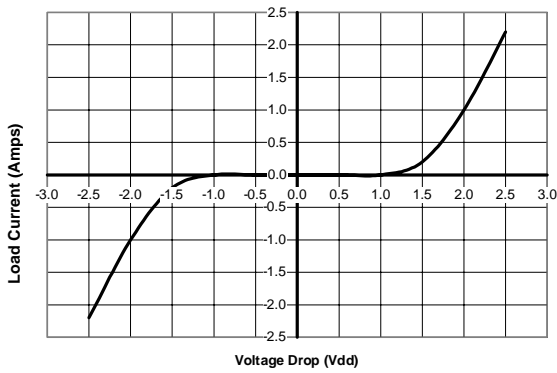

Figure 3. Output Characteristics

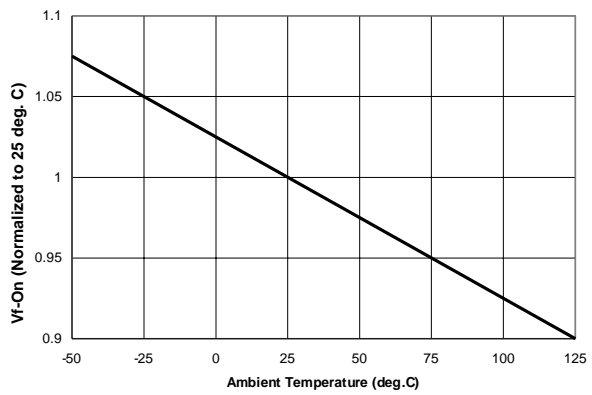

Figure 4. Typical Normalized VCEON

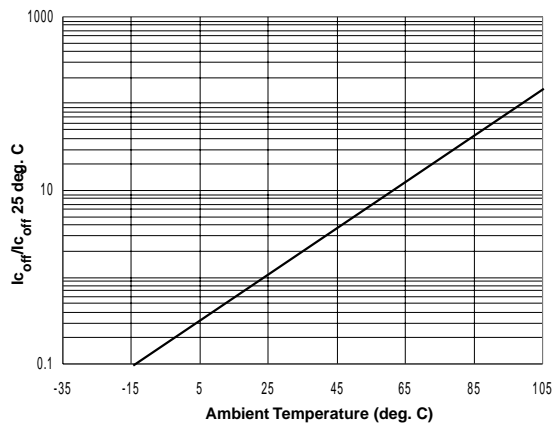

Figure 5. Typical Normalized Off-State Leakage

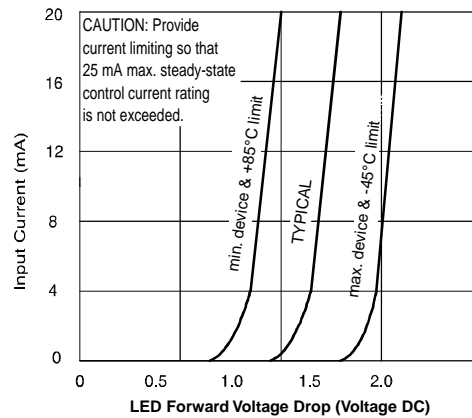

Figure 6. Input Characteristics (Current Controlled)

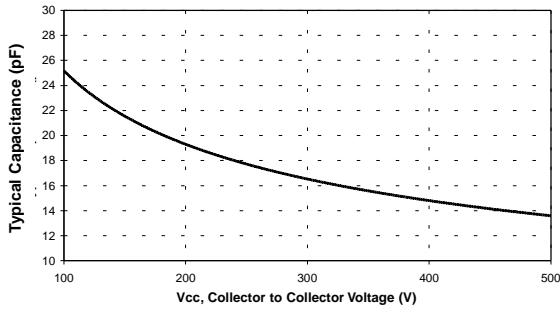

Figure 7. Typical Output Capacitance

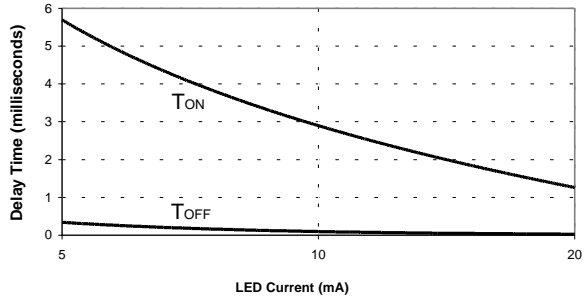

Figure 8. Typical Delay Times

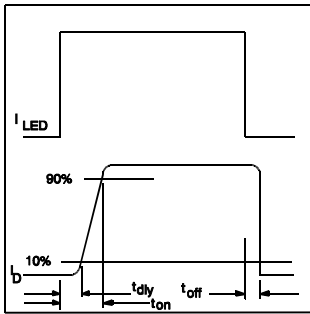

Figure 9. Delay Time Definitions

