

UNCLASSIFIED

DEPARTMENT OF DEFENCE

AR-001-987

DEFENCE SCIENCE AND TECHNOLOGY ORGANISATION

ELECTRONICS RESEARCH LABORATORY

TECHNICAL REPORT

ERL-0137-TR

THE TRIBO-ELECTRIC EFFECT OF LIQUID FLOW AND ITS APPLICATIONS

I.K. Varga

S U M M A R Y

The flow of liquids through dielectric tubes is shown to produce a frictional electromotive force, and an empirical relation is established between the voltage generated and the various experimental factors controlling it.

The application of the effect to the measurement of the flow rate and the electrical resistivity of fluids is discussed.

Approved for Public Release.

POSTAL ADDRESS: Chief Superintendent, Electronics Research Laboratory,
Box 2151, G.P.O., Adelaide, South Australia, 5001.

UNCLASSIFIED

TABLE OF CONTENTS

	Page No.
1. INTRODUCTION	1
2. EXPERIMENTAL ARRANGEMENT AND RESULTS	1 - 4
3. CONCLUSIONS	4
4. ACKNOWLEDGEMENTS	4
REFERENCES	5
TABLE 1. TYPICAL CELL POTENTIAL V_1 AND V_2	6

LIST OF FIGURES

1. Experimental apparatus (schematic)
2. Equivalent circuit
3. EMF as function of water flow rate
4. EMF as function of water resistivity
5. EMF as function of tube length
6. EMF as function of tube diameter
- 7(a) Cell with two Sections AB and BC (schematic)
- 7(b) Equivalent circuit of figure 7(a)

1. INTRODUCTION

In the course of experiments in this laboratory it was found that when deionised water flows through a dielectric tube, a substantial electromotive force is produced along its length. This paper examines the dependence of the e.m.f. on the experimental conditions and discusses its origin and applications.

2. EXPERIMENTAL ARRANGEMENT AND RESULTS

Using the experimental arrangement of figure 1 the electromotive force was observed as a function of water resistivity, flow rate, tube length and bore diameter. As will be more fully discussed below, the open circuit voltage U and the water resistivity ρ can be calculated from voltage measurements across points A and B (see also the equivalent circuit figure 2).

The equivalent circuit assumes that no significant e.m.f. is generated in the high resistance fluid return leads, an assumption valid under our experimental conditions. The open circuit voltage is then given by

$$U = V\left(\frac{R}{r} + 1\right) \tag{1}$$

where r is the resistance of the voltmeter.

The experimentally determined dependence of the voltage on water resistivity, flow rate, tube length and tube diameter is represented in figures 3 to 6. These results, obtained under conditions of turbulent flow, show that U is linearly proportional to the flow rate (figure 3), the electrical resistivity of the fluid (figure 4), and the tube length (figure 5), but that it is inversely proportional to the 5th power of the tube diameter (figure 6).

Empirically one therefore finds that

$$U = k \rho L F d^{-5} \tag{2}$$

where

- ρ = electrical resistivity of the fluid,
- L = tube length,
- F = water flow rate,
- d = tube diameter,
- k = coefficient of proportionality, depending on tube material.

From the experiments it is known that the e.m.f. is only generated whilst water is actually flowing. When this is the case, work is done against friction forces at the tube walls, and it appears reasonable to seek the origin of the e.m.f. in friction effects. To test this hypothesis we note that an empirical formula(ref.1) gives the pressure drop due to friction in a tube carrying a fluid as

$$P_A - P_B = \lambda s \frac{v^2}{d} L \tag{3}$$

where

- P_A = pressure at A,
 P_B = pressure at B,
 L = tube length between A and B,
 λ = frictional coefficient,
 s = density of fluid,
 v = average fluid velocity,
 d = tube diameter.

This represents the work done against friction in moving unit volume of fluid from point A to point B.

Since

$$v = \left(\frac{4}{\pi}\right) \frac{F}{d^2} \quad (4)$$

work is expended against friction at the rate

$$W = \lambda s \left(\frac{4}{\pi}\right)^2 L F^3 d^{-5} \quad (5)$$

when a flow rate F is maintained through the tube.

From equations (2) and (5)

$$U = \frac{k\rho}{\lambda s} \left(\frac{\pi}{4}\right)^2 \frac{W}{F^2} \quad (6)$$

so that at constant flow rate F the voltage U is directly proportional to the frictional power W , supporting our view that we are dealing with a tribo-electric effect. The fraction of the total power expended on generating the e.m.f. is however dependent on the flow and varies as $\frac{1}{F^2}$.

Here it must be remembered that equation (6) rests on the approximate empirical relation (3), where the exponent of v is variously quoted in the range from about 1.85 to 2.0(ref.1). Likewise the coefficient λ is known to be a weak function of F (ref.2). In consequence the $1/F^2$ dependence of U that we have derived, although adequate for our purpose, is not rigorous.

Experimentally we observe not the open circuit voltage U , but a potential V , measured across AB with a voltmeter of resistance r . This potential will be a function not only of r but also of the electrical resistance R of the fluid in the tube, which in turn depends on the resistivity of the fluid, through

$$R = \frac{4L}{\pi d^2} \rho \quad (7)$$

Both U and ρ can be obtained from a set of two potential measurements V_1 and V_2 , made with two different meter resistances r_1 and r_2 . These yield

$$\rho = \frac{\pi d^2}{4L} \left[\frac{V_2 - V_1}{\frac{r_1}{V_1} - \frac{r_2}{V_2}} \right] \quad (8)$$

and

$$U = V_1 \left(\frac{R}{r_1} + 1 \right) = V_2 \left(\frac{R}{r_2} + 1 \right) \quad (9)$$

From such measurements not only ρ and U , but, through equation (2), also F can be derived, i.e. the tribo-electric effect provides a simple means for determining either the electrical resistivity of a liquid or its rate of flow. In developing a practical device for this purpose it must however be borne in mind that in practice the liquid is often circulated in a closed loop, and when voltage measurements are made across points such as A and B, the effect of any e.m.f. generated in the rest of the water line together with the electrical resistance in that line must be considered. Instead of trying to evaluate this effect numerically, it is simpler to eliminate it by separating the rest of the line electrically from the measuring tube Section AB. To achieve this, one can add to AB, which has diameter d_2 and is terminated in short metal sections as shown, another insulating tube BC of diameter d_1 . In addition points A and C are joined by an external conductor as indicated in figure 7(a). This corresponds to the equivalent circuit of figure 7(b). Open circuit voltages U_2 and U_1 are generated in the two sections AB and BC respectively, according to equation (2).

The resultant potential across AB is obtained as

$$V = \frac{U_2 R_1 - U_1 R_2}{\frac{R_1 R_2}{r} + R_1 + R_2} \quad (10)$$

This potential is zero if

$$U_2 R_1 = U_1 R_2 \quad (11)$$

Expressing the resistance of the fluid in each section in terms of ρ , L and d , and substituting for U from equation (2), the expression (11) takes the form

$$k_1 d_1^{-3} = k_2 d_2^{-3} \quad (12)$$

Therefore the potential across AB is zero if the tube sections are made of the same material ($k_1 = k_2$) and if they also have the same diameter. It follows from this that to obtain a non-zero voltage from a device for measuring fluid resistivity, several arrangements can be adopted, that we shall now consider:

(a) $k_1 \neq k_2, d_1 = d_2$

In this case the fluid resistance R_2 in Section AB can be expressed as

$$R_2 = \frac{n+1}{n} \left[\frac{V_2 - V_1}{\frac{r_1}{V_1} - \frac{r_2}{V_2}} \right] \quad (13)$$

where

$$n = \frac{L_1}{L_2}$$

(b) $\frac{d_1 \neq d_2, k_1 = k_2}{\text{Here}}$

$$R_2 = \frac{m+1}{m} \left[\begin{array}{c} V_2 - V_1 \\ \frac{V_1}{r_1} - \frac{V_2}{r_2} \end{array} \right] \quad (14)$$

where

$$m = \frac{L_1}{L_2} \left(\frac{d_2}{d_1} \right)^2$$

In either case, introduction of the appropriate value of R_2 into equation (7) yields the desired resistivity.

As examples of the voltage output derived from a typical device, some experimental values of V_1 and V_2 , together with their corresponding water resistivities and flow rates are listed in Table 1. The measuring tube in this case was made of perspex, with $L_2 = 1.8$ cm, $L_1 = 6$ cm, $d_1 = 0.9$ cm and $d_2 = 0.6$ cm. Voltmeter input resistances r_1 and r_2 of $1 \text{ M}\Omega$ and $100 \text{ M}\Omega$ were used for measuring V_1 and V_2 respectively. As the table shows the available output voltages are in a range that permits measurement with simple instruments.

3. CONCLUSIONS

Our experiments indicate that the voltage produced by the passage of fluids through dielectric tubes is of tribo-electric origin. At constant flow rate the voltage is directly proportional to the frictional power developed, but the fraction of this power available for tribo-electric generation varies approximately with the inverse square of the flow rate.

The tribo-electric effect forms the basis for a very simple technique for the practical determination of either the electrical resistivity or the flow rate of liquids.

4. ACKNOWLEDGEMENTS

The author wishes to thank Mr E.H. Hirsch and Dr R.H. Hartley for their interest, helpful suggestions and for their help in preparing this report. Thanks are also due to Mr L.J. Dunne for his interest and encouragement throughout this work.

REFERENCES

No.	Author	Title
1	Dryden, H.L., Murnaghan, F.D. and Bateman, H.	Hydrodynamics, Dover Publications Inc., Dover, <u>438</u> , 1956
2	Ginzburg, I.P.	Applied Fluid Dynamics, published for the National Science Foundation, Washington DC, by the Israel Program for Scientific Translation, Jerusalem, <u>54</u> , 1963 (Izdatel'stvo Leningradskoga Universiteta, 1958)

TABLE 1. TYPICAL CELL POTENTIALS V_1 AND V_2

V_1 (V)	V_2 (V)	ρ ($M\Omega$ -cm)	F(l/s)
0.0832	1.37	4.85	0.114
0.0903	1.79	6.15	0.114
0.095	2.05	6.88	0.114
0.099	2.40	8.04	0.114
0.1055	2.80	9.11	0.114
0.118	3.69	11.5	0.114
0.123	4.02	12.33	0.114
0.125	4.26	13.15	0.114
0.130	4.69	14.38	0.114
0.131	4.77	14.64	0.114
0.098	3.59	14.73	0.0946
0.076	2.77	14.62	0.0789
0.057	2.08	14.64	0.0631
0.040	1.46	14.64	0.0479
0.0174	0.635	14.64	0.0189
0.131	4.78	14.64	0.114

$L_1 = 6$ cm, $d_1 = 0.9$ cm, $r_1 = 1$ $M\Omega$

$L_2 = 1.8$ cm, $d_2 = 0.6$ cm, $r_2 = 100$ $M\Omega$

MATERIAL = PERSPEX.

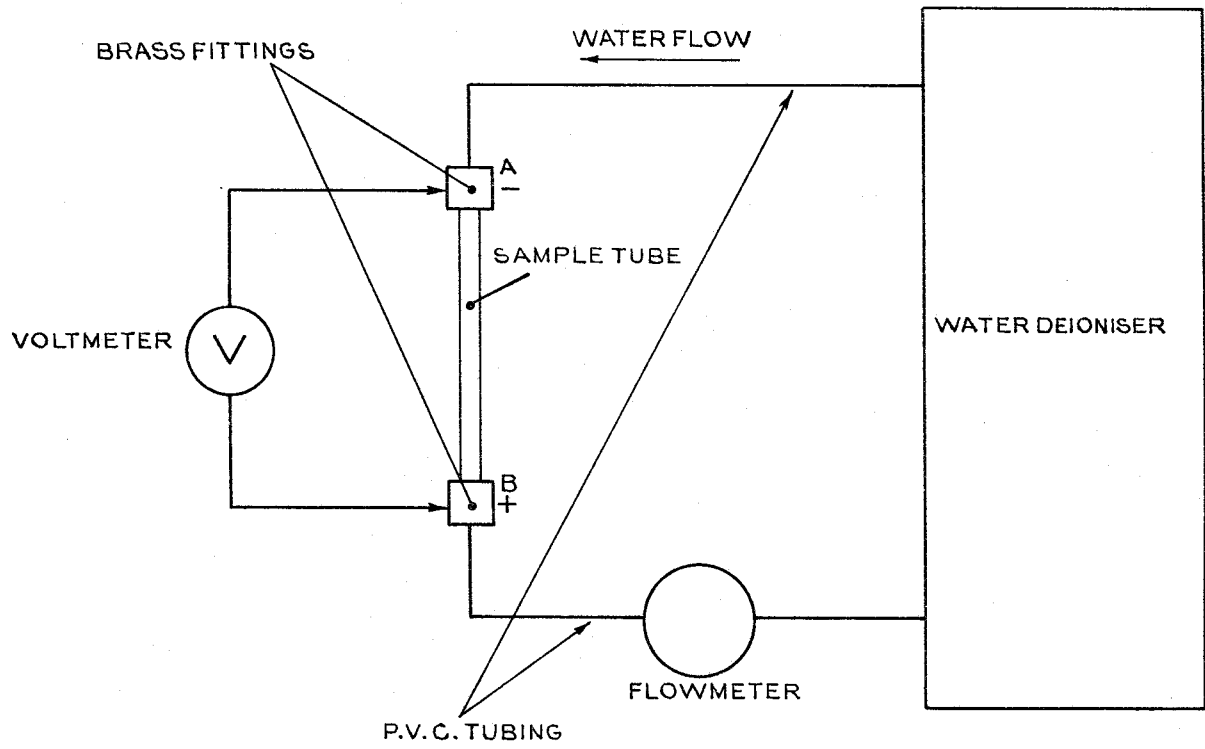

Figure 1. Experimental apparatus (schematic)

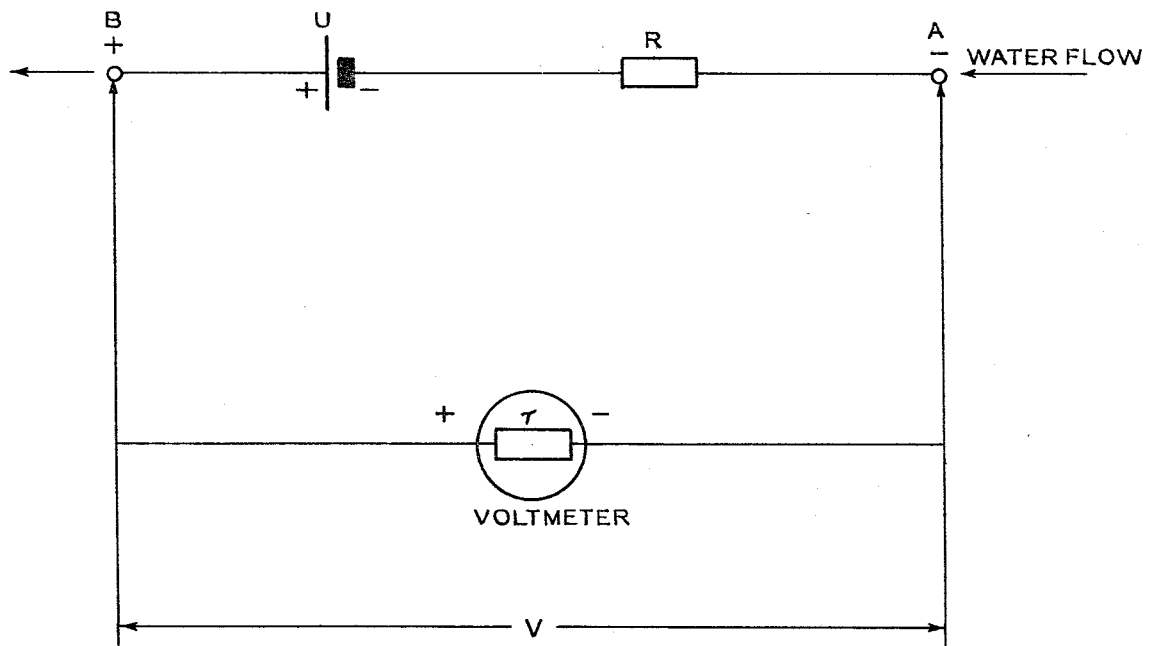

Figure 2. Equivalent circuit

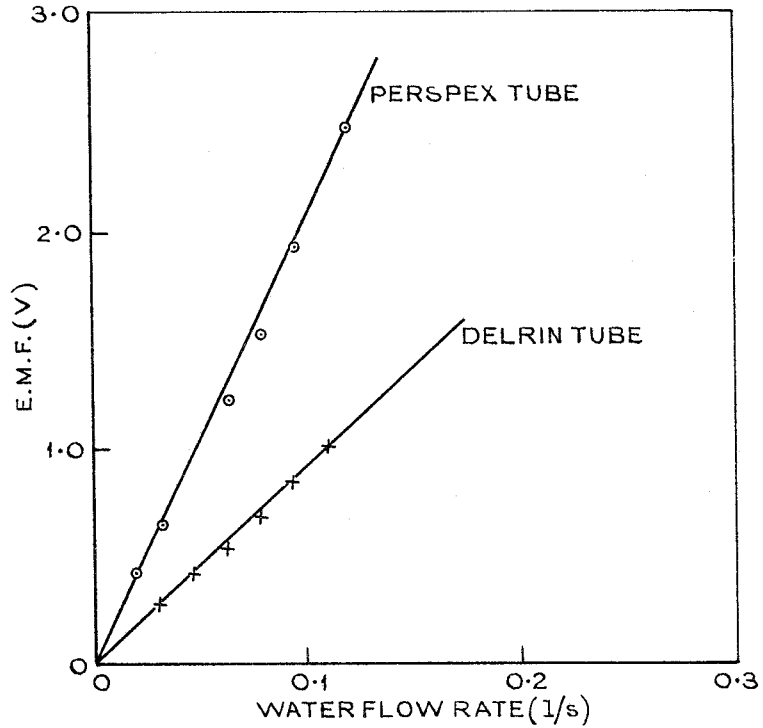

Figure 3. E.m.f. as function of water flow rate

Tube length $L = 7$ cm
Tube diameter $d = 0.92$ cm
Water resistivity $\rho = 7.2 \text{ M}\Omega\text{-cm}$

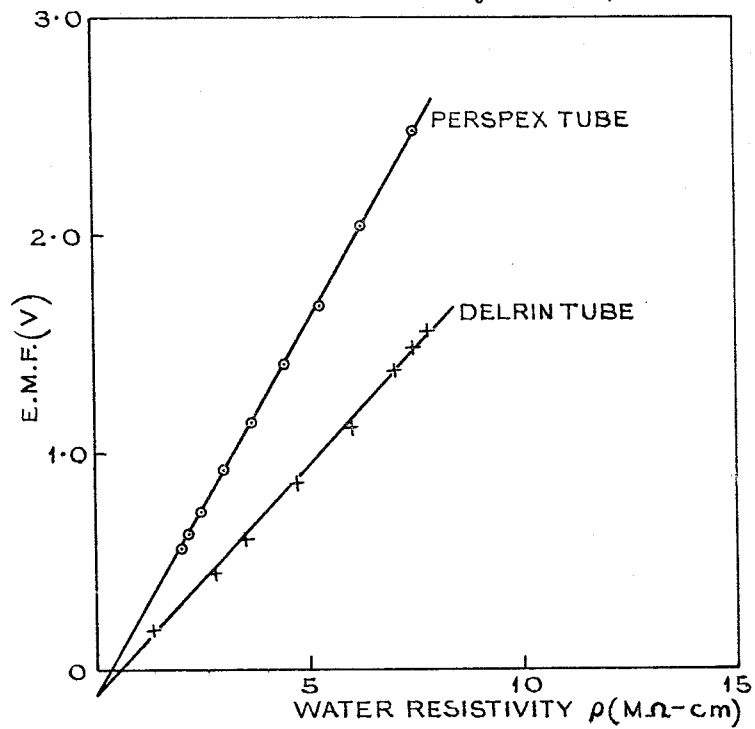

Figure 4. E.m.f. as function of water resistivity

Tube length $L = 7$ cm
Tube diameter $d = 0.92$ cm
Water flow rate $F = 0.114$ l/s

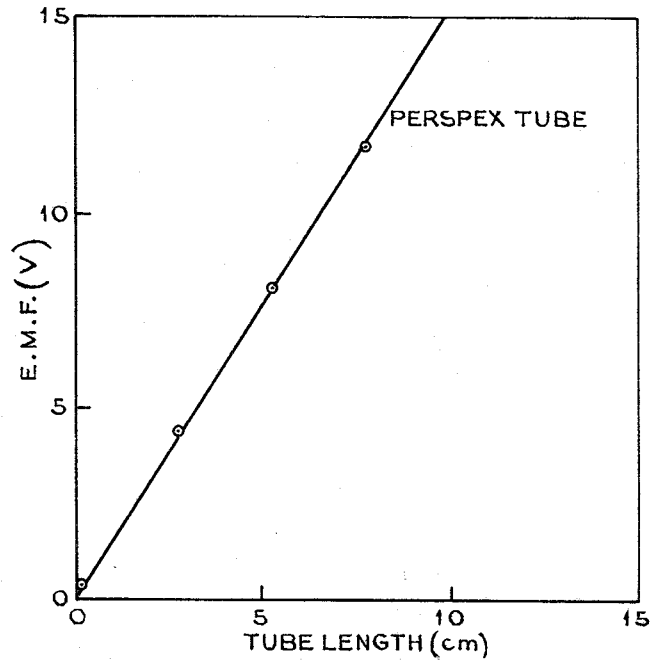

Figure 5. E.m.f. as function of tube length

Water resistivity $\rho = 7.2 \text{ M}\Omega - \text{cm}$
 Tube diameter $d = 0.7 \text{ cm}$
 Water flow rate $F = 0.114 \text{ l/s}$

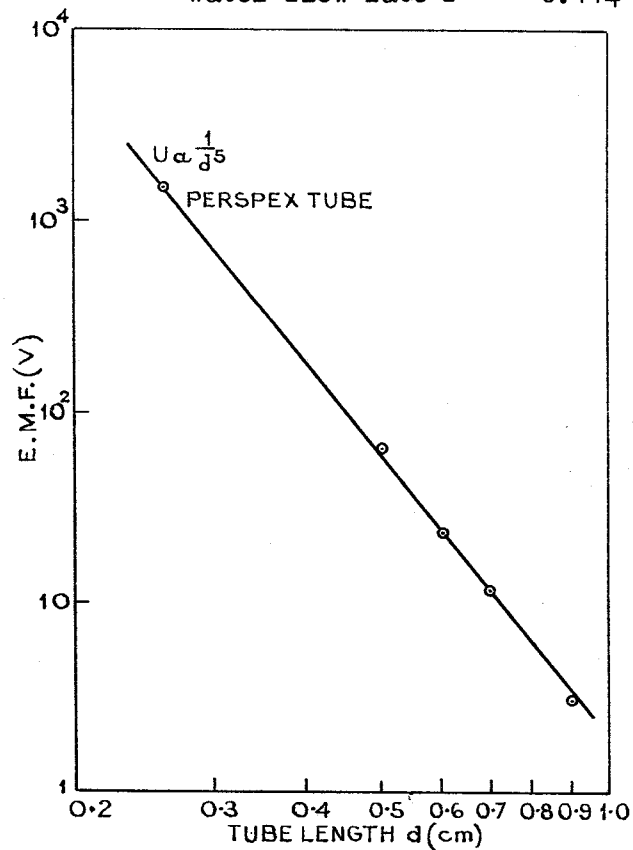

Figure 6. E.m.f. as function of tube diameter

Tube length $L = 7.6 \text{ cm}$
 Water resistivity $\rho = 7.2 \text{ M}\Omega - \text{cm}$
 Water flow rate $F = 0.114 \text{ l/s}$

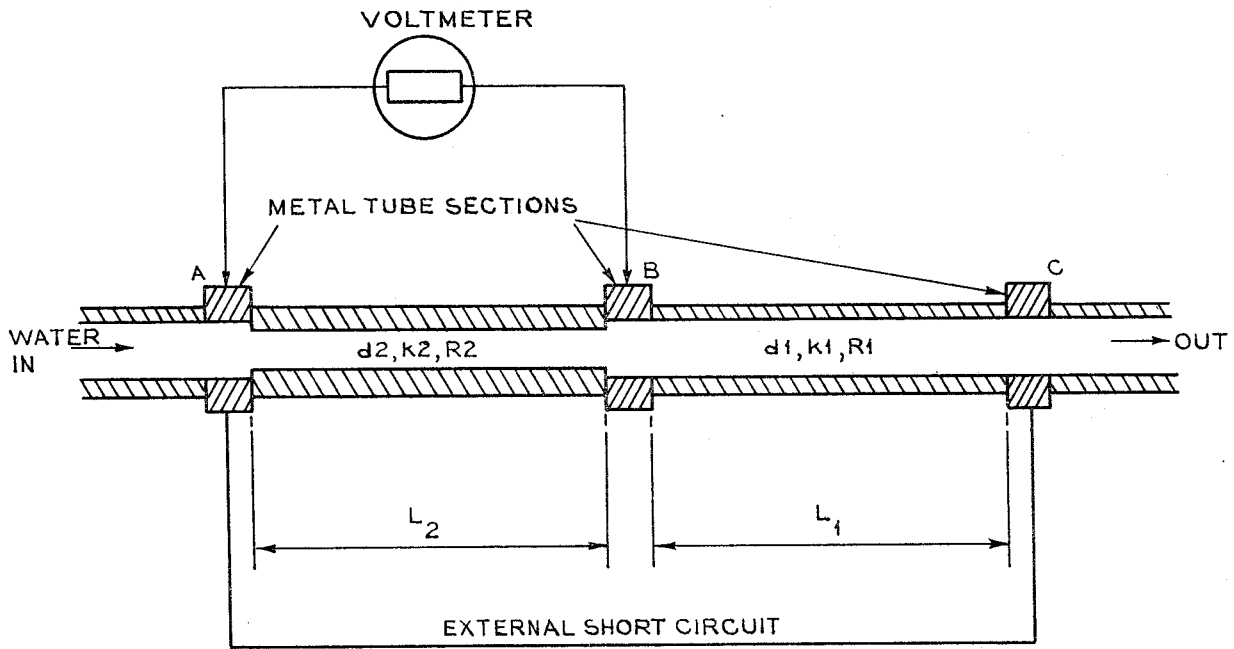

Figure 7(a) Cell with two Sections AB and BC (schematic)

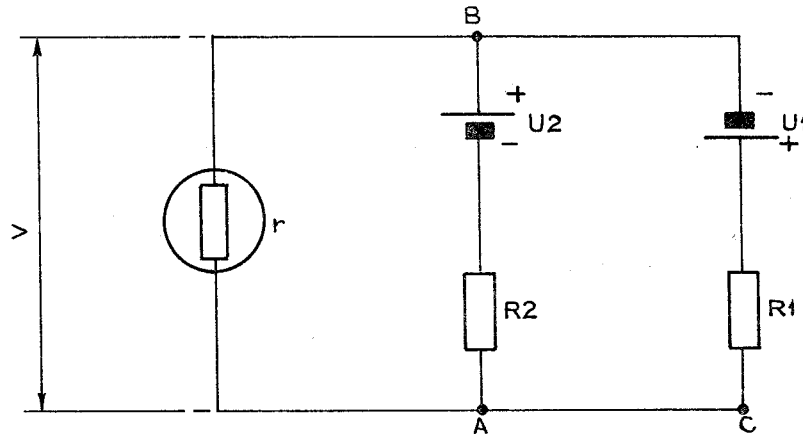

Figure 7(b) Equivalent circuit of figure 7(a)

DOCUMENT CONTROL DATA SHEET

Security classification of this page

UNCLASSIFIED

1	DOCUMENT NUMBERS
AR Number: AR-001-987	
Report Number: ERL-0137-TR	
Other Numbers:	

2	SECURITY CLASSIFICATION
a. Complete Document: Unclassified	
b. Title in Isolation: Unclassified	
c. Summary in Isolation: Unclassified	

3	TITLE
THE TRIBO-ELECTRIC EFFECT OF LIQUID FLOW AND ITS APPLICATIONS	

4	PERSONAL AUTHOR(S):
I.K. Varga	

5	DOCUMENT DATE:
July 1980	

6	6.1 TOTAL NUMBER OF PAGES	10
	6.2 NUMBER OF REFERENCES:	2

7	7.1 CORPORATE AUTHOR(S):
Electronic Research Laboratory	
	7.2 DOCUMENT SERIES AND NUMBER
Electronic Research Laboratory 0137-TR	

8	REFERENCE NUMBERS
a. Task: DST 79/177	
b. Sponsoring Agency:	

9	COST CODE:
313330	

10	IMPRINT (Publishing organisation)
Defence Research Centre Salisbury	

11	COMPUTER PROGRAM(S) (Title(s) and language(s))

12	RELEASE LIMITATIONS (of the document):								
Approved for public release.									
12.0	OVERSEAS	NO	P.R.	1	A	B	C	D	E

Security classification of this page:

UNCLASSIFIED

13 ANNOUNCEMENT LIMITATIONS (of the information on these pages):

No limitation

14 DESCRIPTORS:

a. EJC Thesaurus
TermsFlow
Liquids
Flow rate
Electric power generation
Dielectric properties
Electric potentialb. Non-Thesaurus
Terms

15 COSATI CODES:

1001

16 LIBRARY LOCATION CODES (for libraries listed in the distribution):

17 SUMMARY OR ABSTRACT:

(if this is security classified, the announcement of this report will be similarly classified)

The flow of liquids through dielectric tubes is shown to produce a frictional electromotive force, and an empirical relation is established between the voltage generated and the various experimental factors controlling it.

The application of the effect to the measurement of the flow rate and the electrical resistivity of fluids is discussed.